

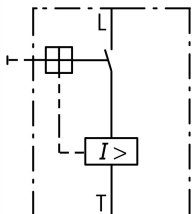

**Short-circuit protective breaker, 3p, im=56A**

**Part no.** PKM0-4  
**Catalog No.** 072727  
**Eaton Catalog No.** XTPM004BNL

**Delivery program**

Product range				PKM0 motor protective circuit-breakers up to 32 A
Basic function				Short-circuit protective device only
				
Notes				Also suitable for motors with efficiency class IE3. IE3-ready devices are identified by the logo on their packaging.
Connection technique				Screw terminals
Contact sequence				

**Max. motor rating**

AC-3				
220 V 230 V 240 V	P	kW		0.75
380 V 400 V 415 V	P	kW		1.5
440 V	P	kW		1.5
500 V	P	kW		2.2
660 V 690 V	P	kW		3
Rated uninterrupted current	$I_u$	A		4

**Setting range**

short-circuit release				
				
max.	$I_{rm}$	A		62

**Notes** An appropriate overload relay must be fitted to protect motors against overload.  
 Can be snapped on to IEC/EN 60715 top-hat rail with 7.5 or 15 mm height.  
 Refer to catalog CA034001DE for the allocation of short circuit protection and contactor

**Notes**

Beim Einsatz des PKM0 als Kurzschlusschutz von schwer anlaufenden Motoren muss der Bemessungsbetriebsstrom  $I_e$  bei der Projektierung der Schaltgeräte mit den folgenden Faktoren überdimensioniert werden:

CLASS 5:	1,0
CLASS 10:	1,0
CLASS 15:	1,22
CLASS 20:	1,41
CLASS 25:	1,58
CLASS 30:	1,73
CLASS 35:	1,89
CLASS 40:	2,0

**Technical data**

<b>General</b>				
Standards				IEC/EN 60947, VDE 0660
Climatic proofing				Damp heat, constant, to IEC 60068-2-78 Damp heat, cyclic, to IEC 60068-2-30
Ambient temperature				
Storage		°C		- 40 - 80
Open		°C		-25 - +55

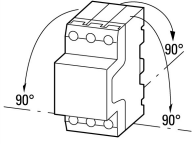
Enclosed	°C	- 25 - 40
Mounting position		
Direction of incoming supply		as required
Degree of protection		
Device		IP20
Terminations		IP00
Protection against direct contact when actuated from front (EN 50274)		Finger and back-of-hand proof
Mechanical shock resistance half-sinusoidal shock 10 ms to IEC 60068-2-27	g	25
Altitude	m	Max. 2000
Terminal capacity main cable		
Screw terminals		
Solid	mm <sup>2</sup>	1 x (1 - 6) 2 x (1 - 6)
Flexible with ferrule to DIN 46228	mm <sup>2</sup>	1 x (1 - 6) 2 x (1 - 6)
Solid or stranded	AWG	18 - 10
Stripping length	mm	10
Specified tightening torque for terminal screws		
Main cable	Nm	1.7
Control circuit cables	Nm	1

### Main conducting paths

Rated impulse withstand voltage	U <sub>imp</sub>	V AC	6000
Overvoltage category/pollution degree			III/3
Rated operational voltage	U <sub>e</sub>	V AC	690
Rated uninterrupted current = rated operational current	I <sub>u</sub> = I <sub>e</sub>	A	4
Rated frequency	f	Hz	40 - 60
Current heat loss (3 pole at operating temperature)		W	5.33
Lifespan, mechanical	Operations	x 10 <sup>6</sup>	0.1
Lifespan, electrical (AC-3 at 400 V)			
Lifespan, electrical	Operations	x 10 <sup>6</sup>	0.1
Max. operating frequency		Ops/h	40
Short-circuit rating			
AC			
Other technical data (sheet catalogue)			Schaltvermögen
Motor switching capacity			
AC-3 (up to 690V)	A		4
DC-5 (up to 250V)	V		4 (3 contacts in series)

### Trip blocks

Temperature compensation			
to IEC/EN 60947, VDE 0660	°C		- 5 ... 40
Operating range	°C		- 25 ... 55
Temperature compensation residual error for T > 40 °C			≤ 0.25 %/K
short-circuit release			Basic device, fixed: 15.5 x I <sub>u</sub>
Short-circuit release tolerance			± 20%

## Design verification as per IEC/EN 61439

Technical data for design verification			
Rated operational current for specified heat dissipation	I <sub>n</sub>	A	4
Heat dissipation per pole, current-dependent	P <sub>vid</sub>	W	0
Equipment heat dissipation, current-dependent	P <sub>vid</sub>	W	5.33
Static heat dissipation, non-current-dependent	P <sub>vs</sub>	W	0
Heat dissipation capacity	P <sub>diss</sub>	W	0

Operating ambient temperature min.	°C	-25
Operating ambient temperature max.	°C	55
IEC/EN 61439 design verification		
10.2 Strength of materials and parts		
10.2.2 Corrosion resistance		Meets the product standard's requirements.
10.2.3.1 Verification of thermal stability of enclosures		Meets the product standard's requirements.
10.2.3.2 Verification of resistance of insulating materials to normal heat		Meets the product standard's requirements.
10.2.3.3 Verification of resistance of insulating materials to abnormal heat and fire due to internal electric effects		Meets the product standard's requirements.
10.2.4 Resistance to ultra-violet (UV) radiation		Meets the product standard's requirements.
10.2.5 Lifting		Does not apply, since the entire switchgear needs to be evaluated.
10.2.6 Mechanical impact		Does not apply, since the entire switchgear needs to be evaluated.
10.2.7 Inscriptions		Meets the product standard's requirements.
10.3 Degree of protection of ASSEMBLIES		Does not apply, since the entire switchgear needs to be evaluated.
10.4 Clearances and creepage distances		Meets the product standard's requirements.
10.5 Protection against electric shock		Does not apply, since the entire switchgear needs to be evaluated.
10.6 Incorporation of switching devices and components		Does not apply, since the entire switchgear needs to be evaluated.
10.7 Internal electrical circuits and connections		Is the panel builder's responsibility.
10.8 Connections for external conductors		Is the panel builder's responsibility.
10.9 Insulation properties		
10.9.2 Power-frequency electric strength		Is the panel builder's responsibility.
10.9.3 Impulse withstand voltage		Is the panel builder's responsibility.
10.9.4 Testing of enclosures made of insulating material		Is the panel builder's responsibility.
10.10 Temperature rise		The panel builder is responsible for the temperature rise calculation. Eaton will provide heat dissipation data for the devices.
10.11 Short-circuit rating		Is the panel builder's responsibility. The specifications for the switchgear must be observed.
10.12 Electromagnetic compatibility		Is the panel builder's responsibility. The specifications for the switchgear must be observed.
10.13 Mechanical function		The device meets the requirements, provided the information in the instruction leaflet (IL) is observed.

## Technical data ETIM 6.0

Low-voltage industrial components (EG000017) / Motor protection circuit-breaker (EC000074)		
Electric engineering, automation, process control engineering / Low-voltage switch technology / Circuit breaker (LV < 1 kV) / Motor protection circuit-breaker (ecl@ss8.1-27-37-04-01 [AGZ529013])		
Overload release current setting	A	0 - 0
Adjustment range undelayed short-circuit release	A	62 - 62
Thermal protection		No
Phase failure sensitive		No
Switch off technique		Magnetic
Rated operating voltage	V	690 - 690
Rated permanent current I <sub>u</sub>	A	4
Rated operation power at AC-3, 230 V	kW	0.75
Rated operation power at AC-3, 400 V	kW	1.5
Type of electrical connection of main circuit		Screw connection
Type of control element		Turn button
Device construction		Built-in device fixed built-in technique
With integrated auxiliary switch		No
With integrated under voltage release		No
Number of poles		3
Rated short-circuit breaking capacity I <sub>cu</sub> at 400 V, AC	kA	150
Degree of protection (IP)		IP20
Height	mm	93
Width	mm	45
Depth	mm	76

## Approvals

Specially designed for North America

No

## Characteristics

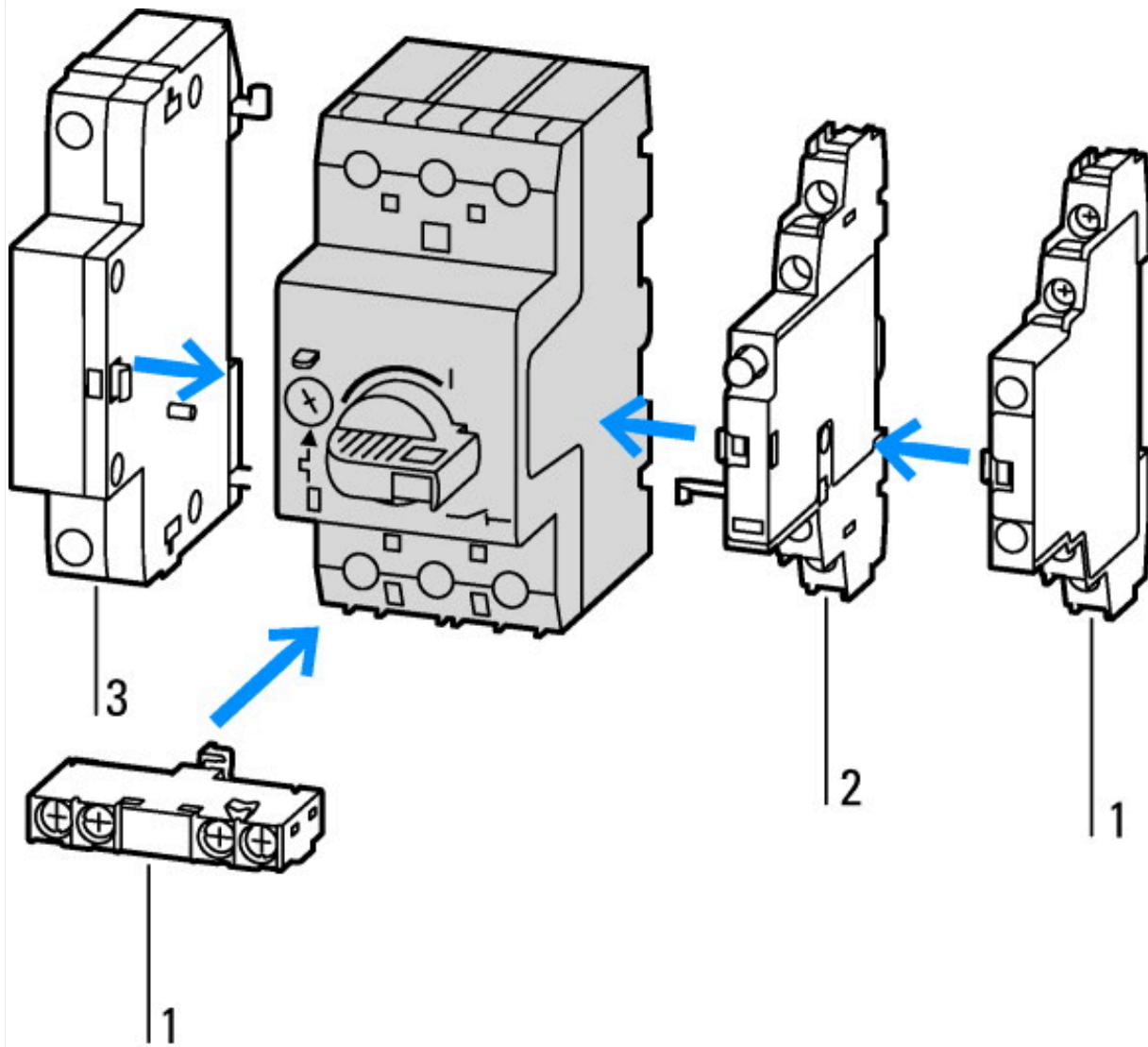

- 1: Standard auxiliary contact
- 2: Trip-indicating auxiliary contact
- 3: Shunt releases, undervoltage releases

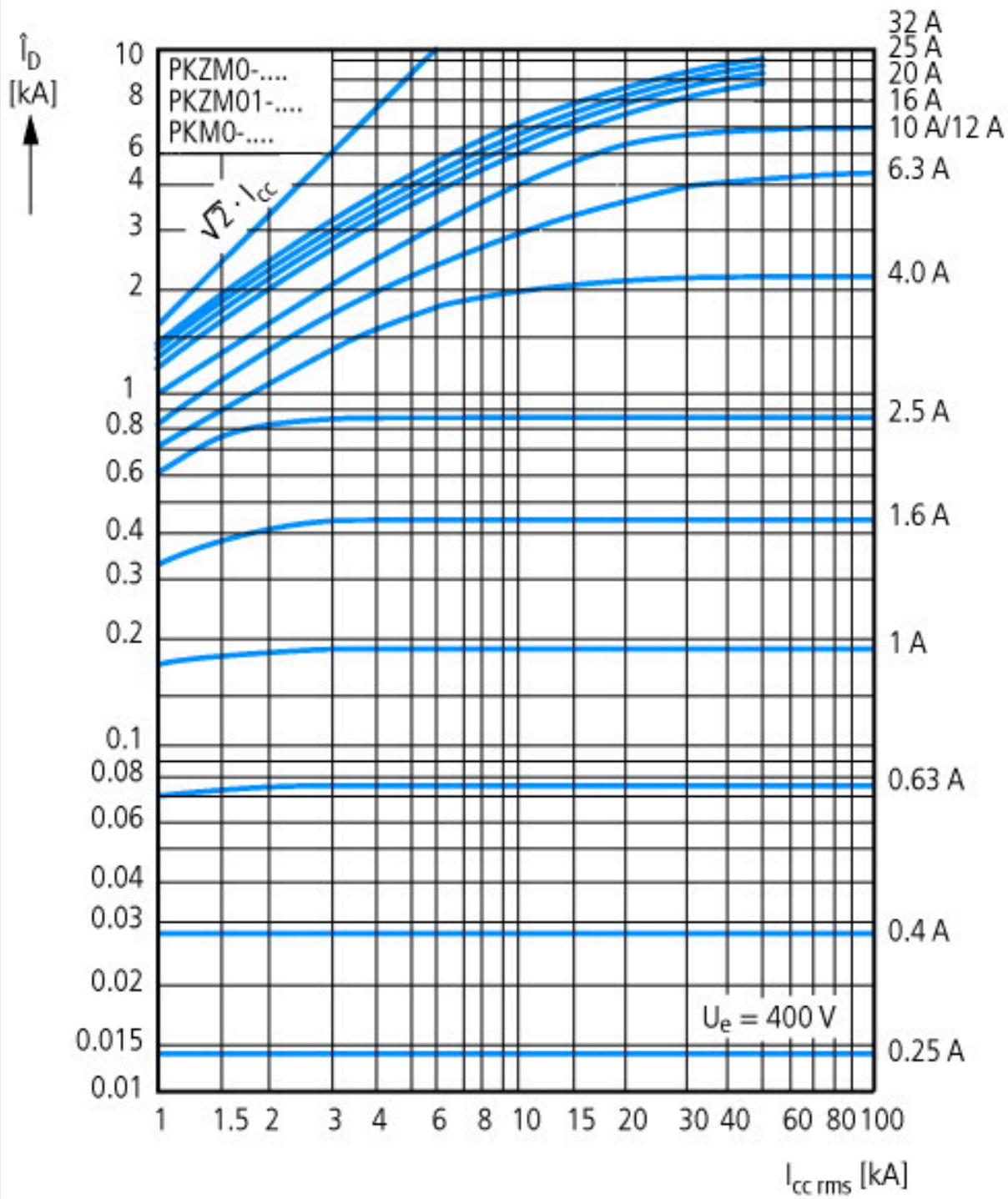

Let-through current

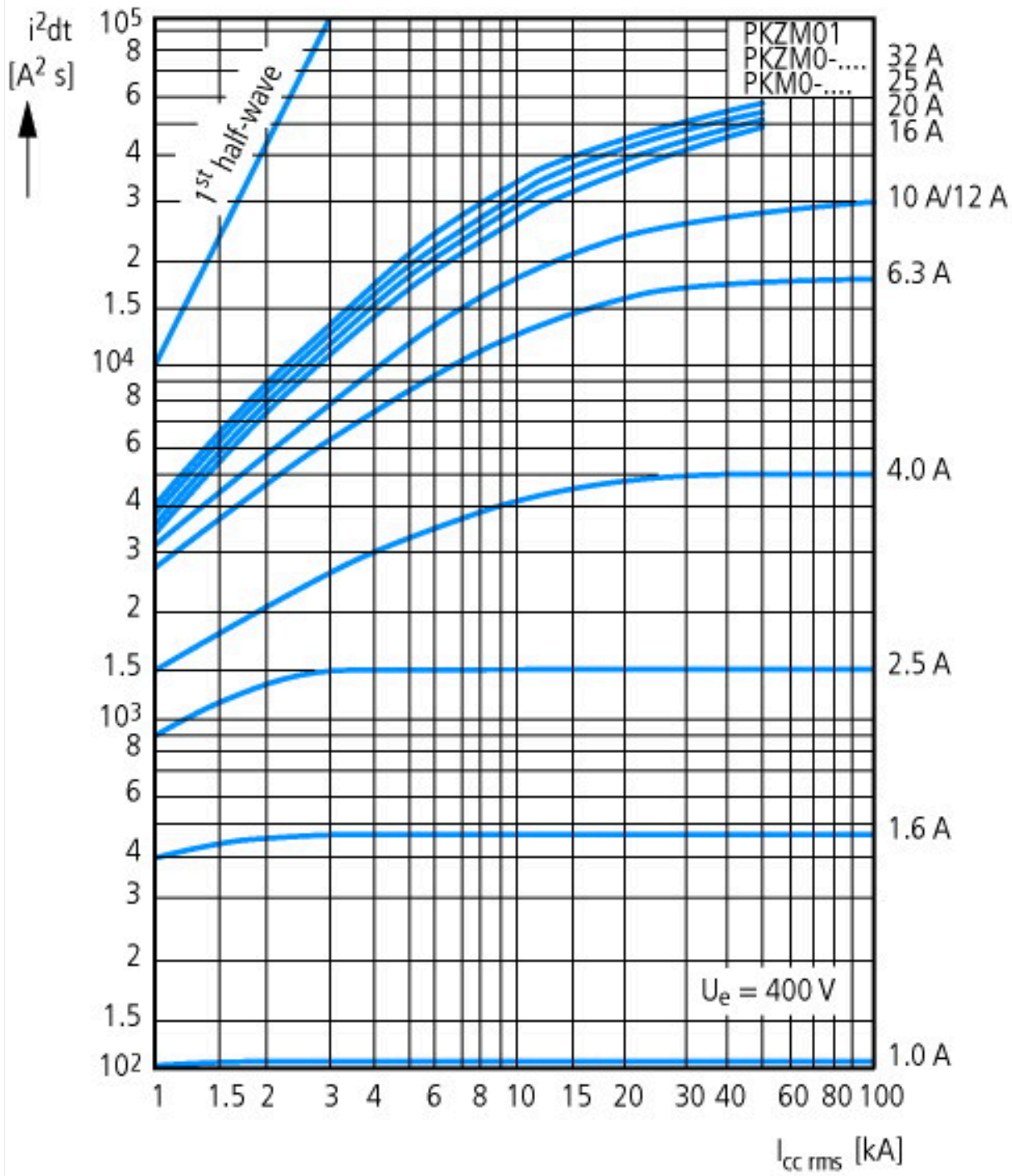

Let-through energy

## Dimensions

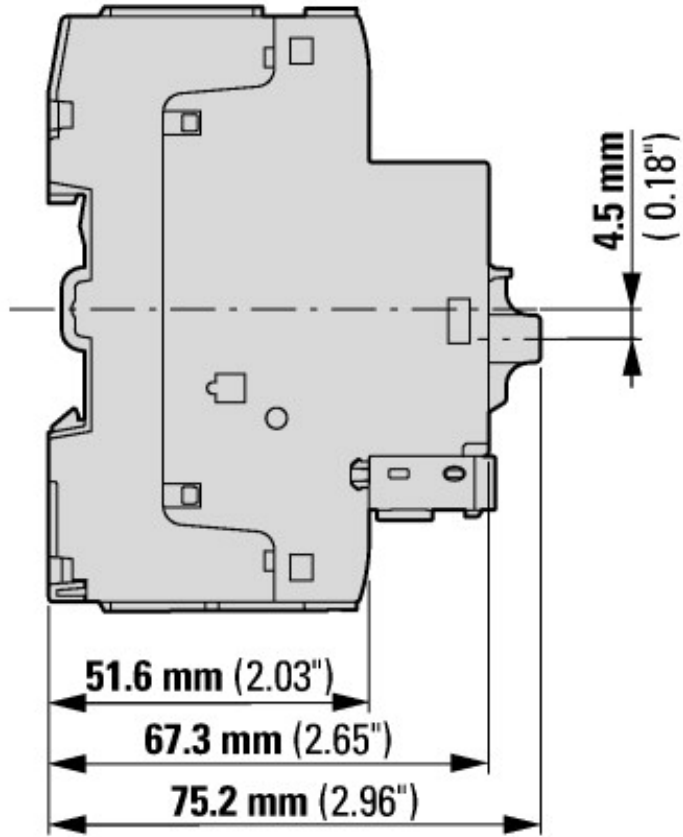
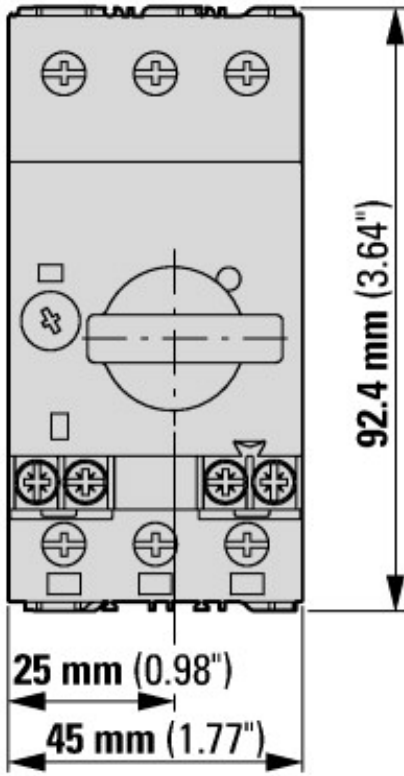

Motor-protective circuit-breaker with standard auxiliary contact  
 PKZM0-...(+NHI-E-...-PKZ0)  
 PKZM0-...-T(+NHI-E-...-PKZ0)  
 PKM0-...(+NHI-E-...-PKZ0)

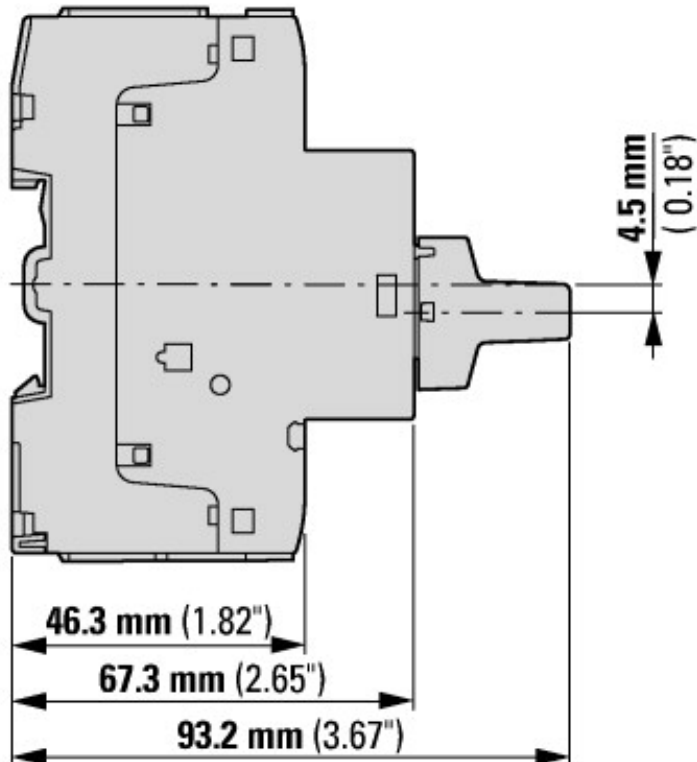
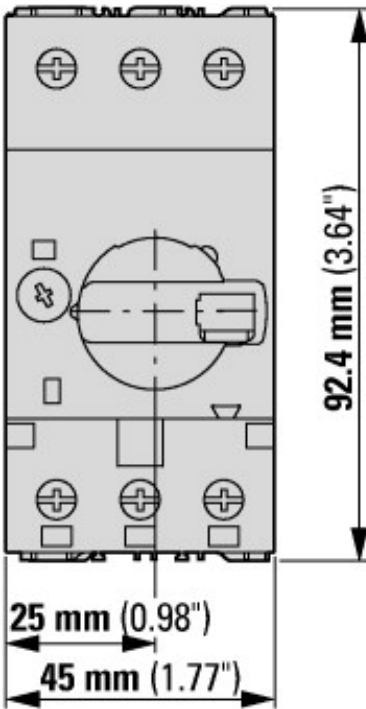

Motor-protective circuit-breakers with lockable rotary handles  
 PKZM0-...+AK-PKZ0

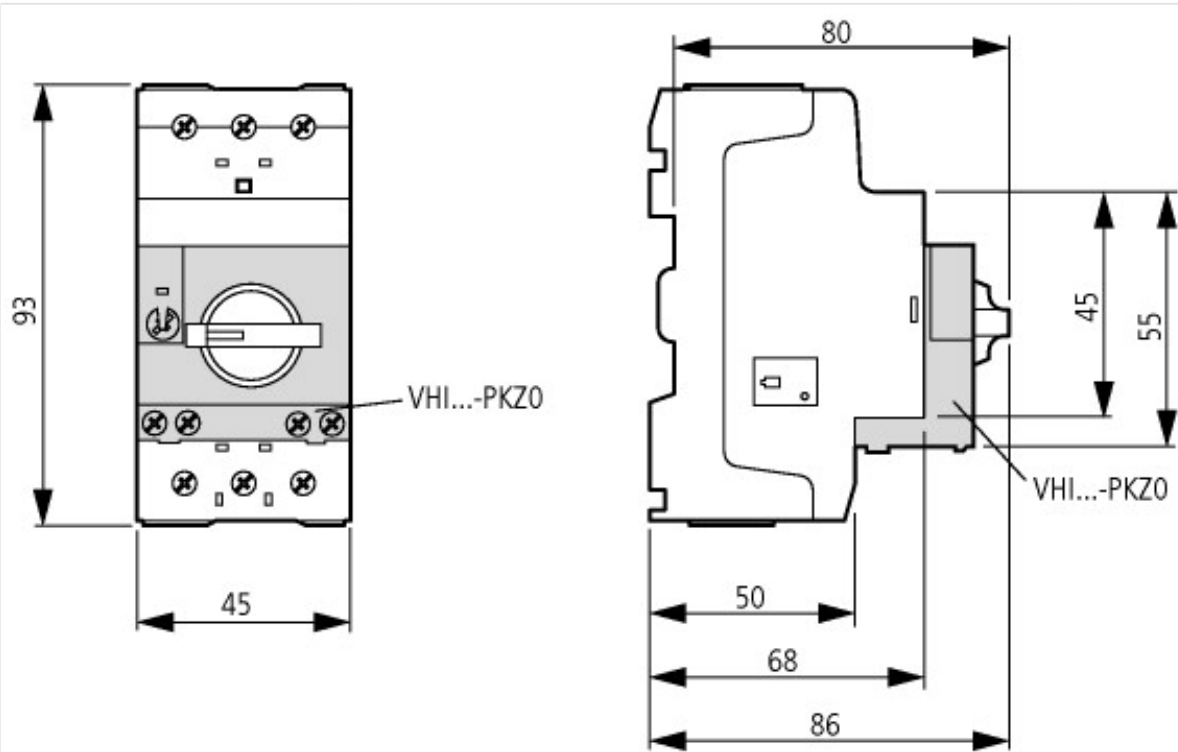

Motor-protective circuit-breakers with early-make auxiliary contacts  
PKZM0-...+VHI-...-PKZ0

## Additional product information (links)

### IL03407010Z (AWA1210-2138) Motor-protective circuit-breaker

IL03407010Z (AWA1210-2138) Motor-protective circuit-breaker [ftp://ftp.moeller.net/DOCUMENTATION/AWA\\_INSTRUCTIONS/IL03407010Z2018\\_04.pdf](ftp://ftp.moeller.net/DOCUMENTATION/AWA_INSTRUCTIONS/IL03407010Z2018_04.pdf)

### IL03407011Z (AWA1210-1925) Motor-protective circuit-breaker

IL03407011Z (AWA1210-1925) Motor-protective circuit-breaker [ftp://ftp.moeller.net/DOCUMENTATION/AWA\\_INSTRUCTIONS/IL03407011Z2018\\_04.pdf](ftp://ftp.moeller.net/DOCUMENTATION/AWA_INSTRUCTIONS/IL03407011Z2018_04.pdf)

Schaltvermögen <http://de.ecat.eaton.com/flip-cat/?edition=HPLTEv1&startpage=>

Motor starters and "Special Purpose Ratings" for the North American market [http://www.moeller.net/binary/ver\\_techpapers/ver953en.pdf](http://www.moeller.net/binary/ver_techpapers/ver953en.pdf)

Busbar Component Adapters for modern Industrial control panels [http://www.moeller.net/binary/ver\\_techpapers/ver960en.pdf](http://www.moeller.net/binary/ver_techpapers/ver960en.pdf)